

1 INSTRUCTIONS AND RECOMMENDATIONS



Switch off the mains before commencing any work



Strip the wires back for about 12mm

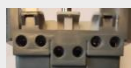

Mechanisms with terminals with automatic connections



For single units, use casings 50mm deep, diameter 67 or 68mm



2 WIRING



Installation by a person with the appropriate skills.

 **N** neutral – blue cable

 **L** phase – red cable

  earth – green/yellow cable

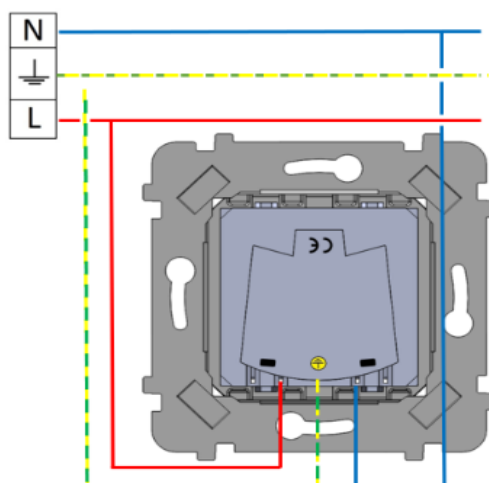

3 FITTING

After wiring according to the instructions, place the mechanism in the flush-mount box and screw on the plate according to the diagram opposite.

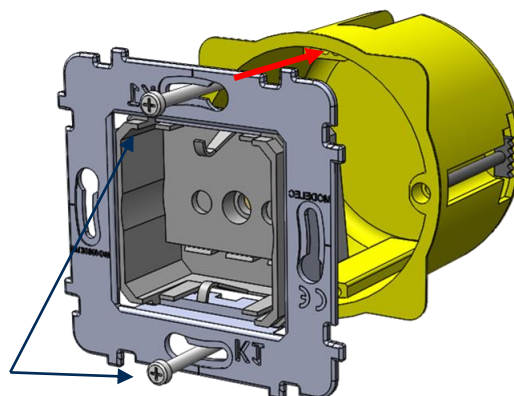

Screws supplied with the flush-mount box.

4 TABLE OF RELEVANT REFERENCES

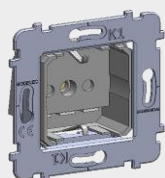

Reference and description:

087620G S SCHUKO SOCKET



087-620B S SCHUKO SOCKET

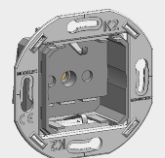

087-620W S SCHUKO SOCKET

Compatible with:

Confidence Collection

Hitera, Karo and Désir Collection

Iris Collection

5 CERTIFICATIONS

The product complies with EC 60884-1:2002 + A1: 2006 + A2: 2013

Placement recommendations for compliance with NF C 15-100 or CENELEC: 2P+E MODULE 16A

IP CLASS: IP21

To be placed in the "Out of Volume" area only

